



3503.1 ... 3604.1 LED CG-S

- Safety luminaire with LED technology for recessed mounting with round or quadratic bezel
- Typical ceiling cut-out diameter of 68 mm and low profile of only 30 mm
- Compact housing for LED supply (required height for entering the ceiling only 100 mm) including through-wiring clamp and strain relief
- Wide light point spacing due to wide light distribution optics and high power LEDs
- Up to 18 m from luminaire to luminaire for escape route illumination and wide area illumination (3x03.1)
- Up to 20 m from luminaire to luminaire for escape route illumination and wide area illumination (3x04.1)
- Minimum service requirement due to high service life of the LEDs (up to 50.000 hours)

3503.1 LED CG-S stainless steel



3503.1 LED CG-S white



Dimensions in mm

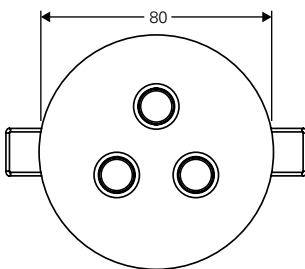

3503.1 LED CG-S

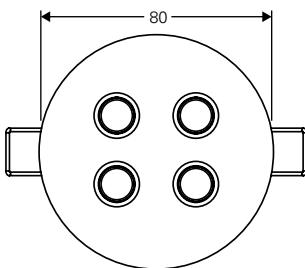

3504.1 LED CG-S

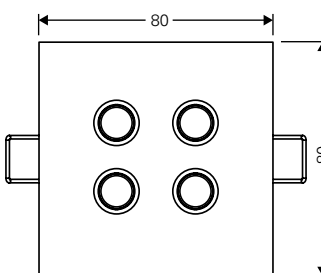

Luminous flux	3503.1: 470 lm 3x04.1: 620 lm
Luminous flux Φ_E/Φ_N at the end of rated operating time	100%
Housing material	Bezel: Stainless steel brushed / sheet steel, white (sim. RAL 9010) Module: Polycarbonate
Weight	Luminaire: 0.13 kg Module: 0.12 kg (incl. enclosure)
Type of mounting	Recessed ceiling mounting
Connection terminals	Loop terminals 3 x 2.5 mm ²
Connection voltage	220 – 240 V, 50/60 Hz 176 V – 275 V DC
Current consumption - battery operation (220 V)	3503.1: 19 mA 3x04.1: 25 mA
Power consumption mains operation (apparent power / effective power)	3503.1: 7.6 VA / 4.4 W 3x04.1: 9.5 VA / 5.8 W
Inrush current	1.5 A
Permissible ambient temperature	-10 °C to +40 °C
Light source	3503.1: HighPower LEDs 3 x 1.1 W 3x04.1: HighPower LEDs 4 x 1.1 W

Ordering details

Type	Scope of supply	Order No.
3503.1 stainless steel	Round LED recessed luminaire with wide beam optics. 3 x HighPowerLED. incl. LED supply and CG-S technology (20 addresses) in housing with strain relief. bezel stainless steel brushed	40071352900
3503.1 white	Round LED recessed luminaire with wide beam optics. 3 x HighPowerLED. incl. LED supply and CG-S technology (20 addresses) in housing with strain relief. bezel white	40071352901
3504.1 stainless steel	Round LED recessed luminaire with wide beam optics. 4 x HighPowerLED. incl. LED supply and CG-S technology (20 addresses) in housing with strain relief. bezel stainless steel brushed	40071352904
3504.1 white	Round LED recessed luminaire with wide beam optics. 4 x HighPowerLED. incl. LED supply and CG-S technology (20 addresses) in housing with strain relief. bezel white	40071352905
3604.1 stainless steel	Quadratic LED recessed luminaire with wide beam optics. 4 x HighPowerLED. incl. LED supply and CG-S technology (20 addresses) in housing with strain relief. bezel stainless steel brushed	40071352908
3604.1 white	Quadratic LED recessed luminaire with wide beam optics. 4 x HighPowerLED. incl. LED supply and CG-S technology (20 addresses) in housing with strain relief. bezel white	40071352909
	Plastic enclosure for installation in concrete (suitable from 160 mm ceiling depth). for GuideLed SL 130x1.1 CG-S	40071353169

3503.1 ... 3604.1 LED CG-S

Safety Luminaires for Escape Route Lighting

Planning help for 3503.1 LED CG-S for E = 1.0 lx (0.5 lx)

Measuring level 0.02 m, maintenance factor MF = 80 %, battery operation, distances in m

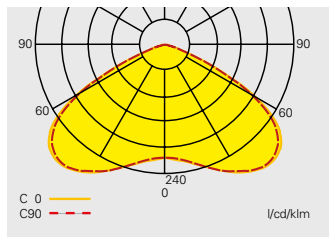

Dimensions in mm

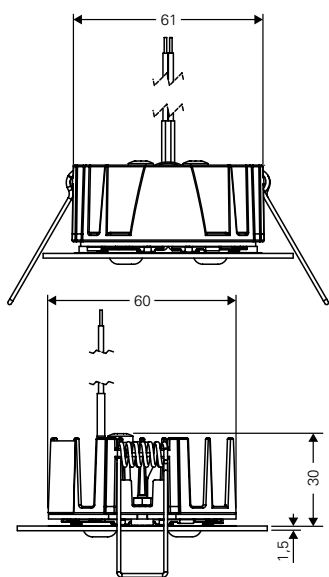

Ceiling cut out: D = 68 mm
Slab thickness 1-20 mm

Montagehöhe in Meter	Montagearten	L1	L2	L3	L4
2.5	Ceiling mounting	4.7 (5.4)	10.7 (12.2)	4.7 (5.4)	10.8 (12.2)
3.0	Escape route centre	5.2 (6.0)	12.0 (13.7)	5.2 (6.1)	12.1 (13.8)
3.5		5.6 (6.6)	13.2 (15.1)	5.6 (6.7)	13.3 (15.2)
4.0		5.9 (7.1)	14.2 (16.4)	6.0 (7.2)	14.4 (16.5)
4.5		6.1 (7.6)	15.1 (17.6)	6.2 (7.7)	15.3 (17.8)
5.0		6.3 (7.9)	15.8 (18.8)	6.3 (8.0)	16.0 (18.9)
5.5		6.3 (8.2)	16.5 (19.8)	6.4 (8.3)	16.7 (20.0)
6.0		6.3 (8.5)	17.1 (20.8)	6.4 (8.6)	17.3 (21.0)
6.5		6.2 (8.7)	17.4 (21.6)	6.3 (8.8)	17.6 (21.8)
7.0		6.1 (8.8)	17.7 (22.3)	6.1 (9.0)	17.9 (22.6)
7.5		5.7 (9.0)	17.9 (23.0)	5.8 (9.1)	18.1 (23.2)
8.0		5.2 (9.0)	17.9 (23.6)	5.3 (9.1)	18.2 (23.9)
8.5		4.4 (8.9)	17.9 (24.1)	4.4 (9.0)	18.1 (24.4)
9.0		2.1 (8.9)	17.7 (24.5)	2.4 (9.0)	17.9 (24.8)
9.5		- (8.7)	17.4 (24.8)	- (8.7)	16.8 (25.1)
10.0		- (8.7)	17.0 (25.0)	- (8.7)	14.3 (25.4)
2.5	Ceiling mounting	3.7 (4.3)	8.7 (9.6)	3.7 (4.3)	8.6 (9.6)
3.0	Room illumination	4.1 (4.7)	9.8 (11.0)	4.0 (4.6)	9.7 (10.9)
3.5		4.4 (5.0)	10.7 (12.2)	4.4 (5.0)	10.7 (12.2)
4.0		4.7 (5.4)	11.7 (13.3)	4.6 (5.4)	11.6 (13.3)
4.5		4.8 (5.7)	12.5 (14.4)	4.8 (5.7)	12.5 (14.3)
5.0		4.9 (6.0)	13.3 (15.3)	4.9 (6.0)	13.3 (15.3)
5.5		5.0 (6.3)	14.1 (16.2)	4.9 (6.3)	14.0 (16.2)
6.0		5.0 (6.5)	14.8 (17.1)	4.8 (6.5)	14.7 (17.1)
6.5		4.9 (6.7)	15.3 (18.0)	4.8 (6.5)	15.3 (17.9)
7.0		4.7 (6.7)	15.8 (18.8)	4.7 (6.6)	15.8 (18.7)
7.5		4.6 (6.7)	16.3 (19.5)	4.4 (6.7)	16.3 (19.5)
8.0		4.3 (6.8)	16.7 (20.3)	4.1 (6.6)	16.7 (20.2)
8.5		3.9 (6.7)	17.1 (20.9)	3.6 (6.7)	17.1 (20.9)
9.0		3.4 (6.7)	17.3 (21.5)	3.3 (6.6)	17.5 (21.5)
9.5		3.0 (6.6)	17.6 (22.1)	2.5 (6.4)	17.6 (22.0)
10.0		0.9 (6.4)	17.9 (22.5)	1.0 (6.3)	17.3 (22.5)

Planning help for 3504.1/3604.1 LED CG-S for E = 1.0 lx (0.5 lx)

Measuring level 0.02 m. maintenance factor MF = 80 %. battery operation. distances in m

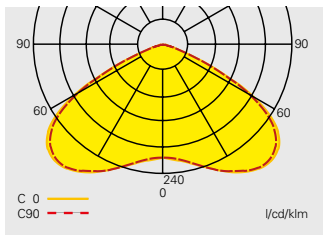

Dimensions in mm

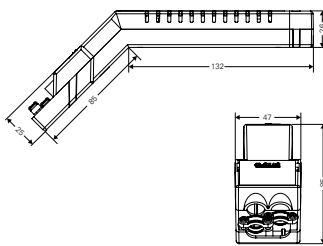

Module housing

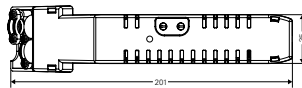

Montagehöhe in Meter	Montagearten	L1	L2	L3	L4
2.5	Ceiling mounting	5.0 (5.7)	11.3 (12.7)	5.0 (5.7)	11.4 (12.7)
3.0	Escape route centre	5.5 (6.3)	12.7 (14.4)	5.6 (6.4)	12.7 (14.5)
3.5		6.0 (7.0)	14.0 (15.9)	6.1 (7.0)	14.0 (16.0)
4.0		6.4 (7.6)	15.1 (17.3)	6.5 (7.6)	15.2 (17.4)
4.5		6.7 (8.1)	16.2 (18.6)	6.8 (8.2)	16.3 (18.7)
5.0		7.0 (8.6)	17.1 (19.9)	7.1 (8.7)	17.3 (20.0)
5.5		7.1 (8.9)	17.9 (21.0)	7.2 (9.0)	18.1 (21.2)
6.0		7.3 (9.3)	18.5 (22.1)	7.3 (9.4)	18.8 (22.3)
6.5		7.3 (9.6)	19.2 (23.1)	7.4 (9.7)	19.4 (23.4)
7.0		7.3 (9.8)	19.7 (24.1)	7.3 (10.0)	19.9 (24.3)
7.5		7.1 (10.0)	20.0 (24.9)	7.2 (10.1)	20.3 (25.1)
8.0		7.0 (10.1)	20.3 (25.6)	7.0 (10.3)	20.5 (25.9)
8.5		6.7 (10.3)	20.5 (26.2)	6.7 (10.4)	20.8 (26.5)
9.0		6.2 (10.3)	20.6 (26.9)	6.3 (10.4)	20.9 (27.2)
9.5		5.5 (10.3)	20.6 (27.5)	5.6 (10.4)	20.8 (27.8)
10.0		4.4 (10.2)	20.5 (27.9)	4.5 (10.4)	20.7 (28.3)
2.5	Ceiling mounting	4.0 (4.4)	9.1 (10.2)	3.9 (4.4)	9.0 (10.1)
3.0	Room illumination	4.3 (5.0)	10.3 (11.4)	4.2 (5.0)	10.2 (11.4)
3.5		4.6 (5.4)	11.3 (12.8)	4.6 (5.3)	11.3 (12.7)
4.0		5.0 (5.7)	12.3 (14.0)	4.9 (5.6)	12.3 (13.9)
4.5		5.2 (6.0)	13.2 (15.1)	5.2 (6.0)	13.2 (15.1)
5.0		5.4 (6.4)	14.1 (16.2)	5.4 (6.3)	14.1 (16.1)
5.5		5.5 (6.7)	14.9 (17.1)	5.5 (6.7)	15.0 (17.1)
6.0		5.6 (7.0)	15.7 (18.1)	5.5 (6.9)	15.7 (18.0)
6.5		5.6 (7.2)	16.4 (19.0)	5.6 (7.2)	16.4 (19.0)
7.0		5.6 (7.5)	17.1 (19.9)	5.5 (7.4)	17.1 (19.8)
7.5		5.5 (7.5)	17.7 (20.7)	5.4 (7.5)	17.6 (20.7)
8.0		5.4 (7.6)	18.2 (21.5)	5.2 (7.5)	18.1 (21.5)
8.5		5.2 (7.7)	18.6 (22.3)	5.1 (7.5)	18.6 (22.2)
9.0		5.0 (7.7)	19.1 (23.0)	4.7 (7.6)	19.0 (23.0)
9.5		4.6 (7.7)	19.5 (23.7)	4.3 (7.6)	19.4 (23.7)
10.0		4.2 (7.7)	19.8 (24.3)	3.9 (7.6)	19.8 (24.3)