

GuideLed SL 13012.1 CG-S

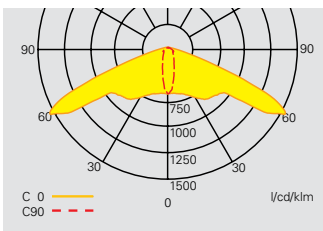

Light distribution curve
GuideLed SL 13012.1 CG-S surface
with asymmetric optics

GuideLed SL 13022.1 CG-S

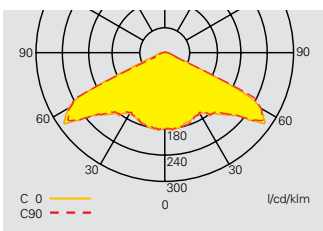

Light distribution curve
GuideLed SL 13022.1 CG-S surface
with symmetric optics

GuideLed SL 13012.1, 13022.1 CG-S

- Safety luminaire with LED technology for surface mounting
- Slender, discrete design with low height of 32mm
- Special LED optics ensure especially efficient escape route illumination or uniform anti-panic illumination
- High Spacing by exact light direction and highly-efficient HighPowerLEDs
- Up to 27 m from luminaire to luminaire with optics for escape route illumination
- Up to 12 m from luminaire to luminaire with optics for antipanic illumination
- Minimum service requirement due to high service life of the LEDs (50,000 hours)

Luminous flux Φ_N	Asymmetric optics 250 lm Symmetric optics 250 lm
Luminous flux Φ_E/Φ_N at end of rated operating time	100%
Housing material	PC, Aluminium
Housing colour	White RAL 9016
Weight	0.33 kg
Type of mounting	Surface mounting
Terminals	2 x 3 x 2,5 mm ²
Connection voltage	220- 240 V AC, 50/60 Hz 176- 275 V DC
Current consumption- battery operation (220 V)	20 mA
Power consumption mains operation (apparent power/effective power)	8.0 VA / 3.9 W
Permissible ambient temperature	-20°C bis +40°C
Light source	HighPower LED 1 x 2 W

Ordering details

Scope of supply	Order No.
GuideLed SL 13012.1 CG-S surface mounting with asymmetric optics for escape route illumination, LED supply and CG-S technology (20 addresses)	40071354482
GuideLed SL 13022.1 CG-S surface mounting with symmetric optics for anti-panic or open space illumination, LED supply and CG-S technology (20 addresses)	40071354483
Additional enclosure for GuideLed SL 130x2.1, for more space for wiring and cable entry, including through-wiring terminal and connection cable to luminaire	40071354489

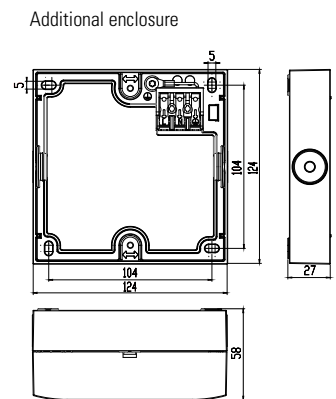
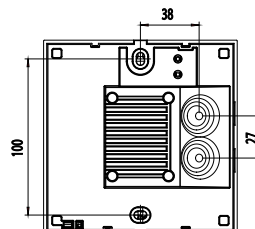
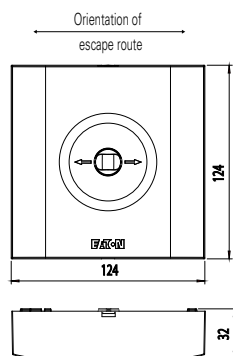

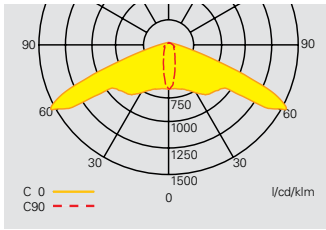

Planning assistance for GuideLed SL CG-S with asymmetric optics

Measuring height 0.02 m, maintenance factor MF = 80 %, battery operation

Mounting height [m]	Type of mounting	L1	L2	L3	L4
2.5	Ceiling mounting	2.3 (3.4)	6.8 (8.3)	6.4 (7.1)	14.1 (15.6)
3.0	Escape route	2.3 (3.2)	6.4 (9.2)	7.3 (8.1)	16.1 (17.8)
3.5	centre	2.3 (3.2)	6.5 (9.7)	8.1 (9.0)	17.9 (19.9)
4.0		2.3 (3.3)	6.5 (9.4)	8.8 (9.9)	19.7 (21.9)
4.5		2.3 (3.3)	6.6 (9.1)	9.5 (10.7)	21.4 (23.7)
5.0		2.2 (3.3)	6.6 (9.2)	10.0 (11.5)	23.0 (25.6)
5.5		2.1 (3.3)	6.6 (9.2)	10.4 (12.2)	24.4 (27.4)
6.0		2.0 (3.3)	6.5 (9.3)	10.7 (12.9)	25.8 (29.1)
6.5		1.9 (3.2)	6.4 (9.4)	7.9 (13.5)	27.0 (30.8)
7.0		1.8 (3.1)	6.2 (9.4)	7.6 (14.0)	26.0 (32.3)
7.5		1.7 (3.1)	6.1 (9.3)	7.3 (14.5)	25.9 (33.7)
8.0		1.6 (2.9)	5.8 (9.3)	7.0 (14.8)	26.2 (35.2)
8.5		1.4 (2.8)	5.7 (9.3)	6.7 (15.1)	26.4 (36.6)
9.0		1.2 (2.8)	5.5 (9.1)	6.1 (14.9)	26.1 (37.8)
9.5		1.0 (2.7)	5.3 (9.0)	4.7 (10.9)	21.9 (37.6)
10.0		0.6 (2.5)	5.0 (8.8)	2.5 (10.7)	21.4 (36.7)



Escape route illumination with asymmetric optics

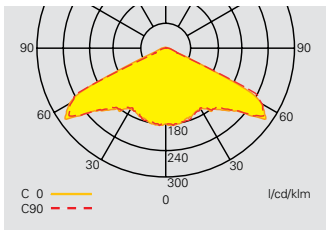

Planning assistance for GuideLed SL CG-S with symmetric optics

Measuring height 0.02 m, maintenance factor MF = 80 %, battery operation

Mounting height [m]	Type of mounting	L1	L2	L3	L4
2.5	Ceiling mounting	4.4 (5.0)	9.9 (10.4)	4.4 (4.9)	9.8 (10.4)
3.0	Escape route	4.6 (5.9)	11.2 (12.3)	4.6 (5.7)	11.2 (12.1)
3.5	centre	4.5 (6.2)	12.3 (14.0)	4.6 (6.2)	12.3 (13.8)
4.0		3.5 (6.4)	12.5 (15.2)	3.8 (6.4)	12.5 (15.2)
4.5		2.9 (6.6)	13.0 (16.4)	3.2 (6.6)	12.7 (16.4)
5.0		2.4 (6.2)	12.3 (17.4)	2.4 (6.4)	12.4 (17.4)
5.5		1.9 (5.3)	10.6 (17.5)	1.8 (5.5)	11.0 (17.6)
6.0		0.7 (4.7)	9.4 (17.8)	0.9 (4.8)	9.6 (17.9)
2.5	Ceiling mounting	4.3 (4.4)	9.8 (10.3)	4.1 (10.3)	9.5 (10.3)
3.0	Room illumination	4.4 (5.2)	11.1 (12.0)	4.6 (5.2)	11.0 (11.9)
3.5		4.7 (5.6)	12.2 (13.6)	5.0 (5.8)	12.2 (13.5)
4.0		2.9 (5.9)	12.1 (15.0)	2.9 (6.3)	12.4 (15.0)
4.5		2.7 (6.2)	12.6 (16.3)	2.5 (6.5)	12.5 (16.3)
5.0		1.0 (6.4)	12.2 (17.2)	0.5 (6.8)	12.5 (17.4)
5.5		0.5 (4.3)	11.8 (17.2)	0.7 (4.5)	11.5 (17.6)
6.0		1.0 (3.5)	11.7 (17.4)	0.7 (3.7)	11.4 (17.5)
6.5		0.5 (2.8)	12.2 (17.8)	0.5 (1.1)	11.6 (18.0)
7.0		0.5 (1.1)	12.1 (17.3)	0.5 (0.7)	11.2 (17.8)
7.5		0.5 (0.5)	11.8 (14.5)	0.5 (2.9)	11.2 (20.5)
8.0		0.5 (2.4)	11.0 (20.3)	0.5 (0.5)	10.9 (14.8)
8.5		0.7 (0.8)	9.4 (21.7)	0.7 (0.7)	9.3 (13.7)
9.0		0.6 (0.5)	8.4 (17.8)	0.6 (0.5)	8.3 (16.5)



Escape route illumination with symmetric optics



Room illumination with symmetric optics